



URODYNAMIC CATHETERS AND ACCESSORIES

Menfis Division

Divisional Office:

Via della Beverara, 46/D - 40131 Bologna Italy.

Tel +39 051 635 10 74 - Fax +39 051 635 10 81

E-mail: info@menfis.it - Web site: www.menfis.it

MEDICA S.p.A.

Index

<i>Catheters for cystometry and pressure flow study</i>	5
<i>Catheters for cystometry, pressure flow study and urethral pressure profile</i>	9
<i>Catheters for cystometry, urethral cystometry an upp</i>	11
<i>Catheters for abdominal pressure</i>	12
<i>Lines and accessories</i>	14
<i>Pressure Transducer</i>	16
<i>Electromyography</i>	17
<i>Uroflowmetry</i>	18
<i>Accessories</i>	19

* *Technical data can be changed without any notice*

A complete range of catheters

The urodynamic catheters offered by *Medica S.p.A. - Menfis Division* have been developed in close cooperation with urodynamicist. For each clinical application we have chosen the most suitable configuration keeping in mind both patients 'comfort and the physicians' needs.

Medica S.p.A. - Menfis Division utilises mainly PEBAX® material for the cannulas. PEBAX® is a copolymer polyeter-amide, biocompatible material with high mechanical features that allows us to manufacture catheters with very thin walls.

The smooth surface makes catheter introduction easy and painless.

The catheters are fitted with female Luer Lock connectors and male Luer Lock caps. The lock connection to the extension lines avoid any possibility of disconnection or leakage preventing incorrect pressure measurements.

The catheters are single-use, supplied sterile in a single pouch.

PEBAX®: features versus other materials

Parameters	Materials			
	POLYURETHANES	P.V.C.	SILICONES	PEBAX®
Friction coefficient	1.35	20	3.0	0.95
Humidity absorption	0.9	0.75	0.1	0.5
Max temperature of sterilization	60 °C	60 °C	120 °C	60 °C
Temperature of incineration	150 °C	95 °C	500 °C	160 °C
Steam sterilizing	NO	NO	YES	NO
Shape memory	HIGH	HIGH	LOW	HIGH
Inner diameter/outer diameter ratio	LOW	LOW	VERY LOW	HIGH

Colour Coding

*The catheters for Urodynamics are single-use, supplied sterile in a single pouch.
The Lock connections are supplied with the following color coding:*

Color	Description	Note
NEUTRAL	Infusion Line	To plug at the pump line
BLUE	Vescical Line	To plug at the Pves transducer
YELLOW	Urethral Line	To plug at the Pura transducer
RED	Rectal Line	To plug at the Pabd transducer

ONE-WAY CATHETERS

1BF-8P

One way catheter for Bladder filling

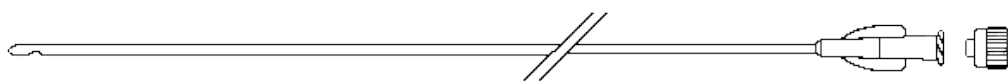

Code	No of ways	Cannula diameter	Cannula length	Material	Q.ty/Box
1BF-8P	1	2.6 mm (8 Fr)	400 mm	PVC	10

1PF-5PE

One way catheter for the measurement of the Bladder Pressure with extension line ending with Blue connector

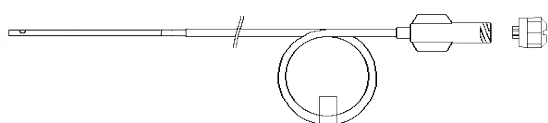

Code	No of ways	Cannula diameter	Cannula length	Line P.V.C. Length	Material	Q.ty/Box
1PF-5E	1	1.65 mm (5 Fr)	400 mm	1800 mm	PVC	10

1PF-4

One way catheter for the measurement of the Bladder Pressure with Blue connector

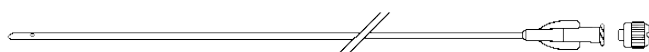

Code	No of ways	Cannula diameter	Cannula length	Material	Q.ty/Box
1PF-4	1	1.35 mm (4 Fr)	400 mm	PEBAX	10

Catheters and lines for Urodynamics:

1PF-4E

One way catheter for the measurement of the Bladder Pressure with extension line that ends with a Blue connector

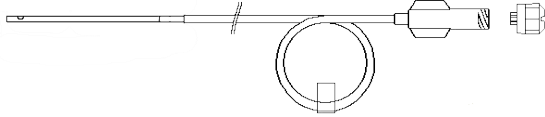

Code	No of ways	Cannula diameter	Cannula length	Line P.V.C. Length	Material	Q.ty/Box
1PF-4E	1	1.35 mm (4 Fr)	400 mm	1800 mm	PEBAX + LINE IN PVC	10

1PF-4L PIG

One way catheter with Pig-Tail tip for the measurement of the Bladder Pressure
 It is fitted with a mandrel to straighten the tip. Once passed inside the bladder, the mandrel is removed so the tip resume the pig-tail shape in order to hold the catheter inside the bladder.
 It has 3 holes on the inner side of the curl

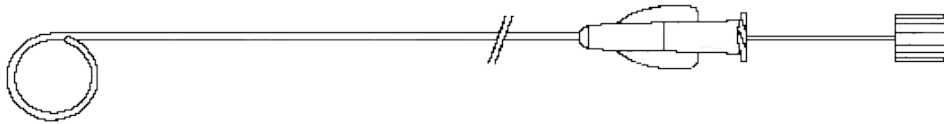

Code	No of ways	Cannula diameter	Cannula length	Material	Q.ty/Box
1PF-4L PIG	1	1.35 mm (4 Fr)	400 mm	PEBAX	10

TWO-WAYS CATHETERS

2CYS-6

Two-way catheter for bladder filling (white connector) and for the measurement of the Bladder Pressure (blue connector) short (30 cm)

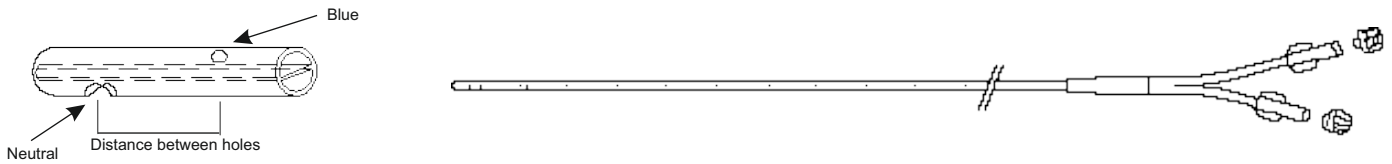

Code	No of ways	Cannula diameter	Cannula length	Distance between BLUE and NEUTRAL	Material	Q.tà/Box
2CYS-6	2	2 mm (6 Fr)	300 mm	10 mm	PEBAX	10

2CYS-6L

Two-way catheter for bladder filling (white connector) and for the measurement of the Bladder Pressure (blue connector) long (40 cm)

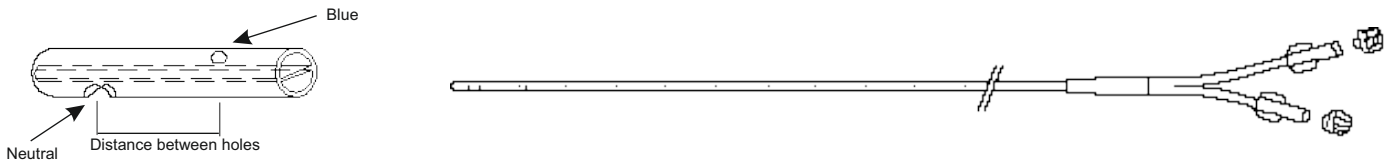

Code	No of ways	Cannula diameter	Cannula length	Distance between BLUE and NEUTRAL	Material	Q.tà/Box
2CYS-6L	2	2 mm (6 Fr)	400 mm	10 mm	PEBAX	10

2CYS-6LE

Two-way catheter for bladder filling (white connector) and for the measurement of the Bladder Pressure (blue connector) fitted with an extension line with Blue connector



Code	No of ways	Cannula diameter	Cannula length	Distance between BLUE and NEUTRAL	Line length	Material	Q.tà/Box
2CYS-6LE	2	2 mm (6 Fr)	400 mm	10 mm	1800 mm	PEBAX + Line in PVC	10

Catheters and lines for Urodynamics:

2CYS-6 PIG

Two-way catheter for bladder filling (white connector) and for the measurement of the Bladder Pressure (blue connector) It is fitted with a mandrel to straighten the tip. Once passed inside the bladder, the mandrel is removed so the tip resume the pig-tail shape in order to hold the catheter inside the bladder.

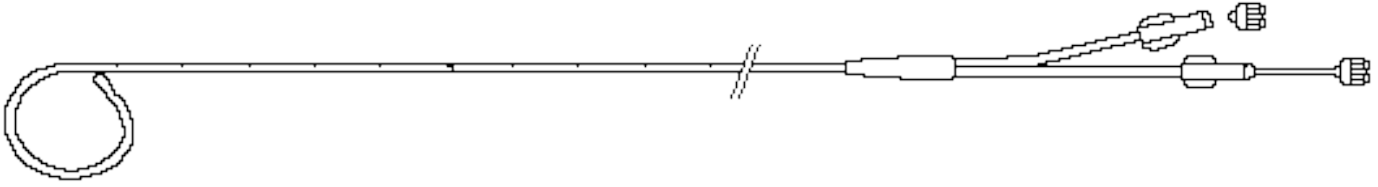

Code	No of ways	Cannula diameter	Cannula length	Distance between BLUE and NEUTRAL	Material	Q.tà/Box
2CYS-6 PIG	2	2 mm (6 Fr)	400 mm	60 mm	PEBAX	10

2CYS-8PE

Two-way catheter for bladder filling (white connector) and for the measurement of the Bladder Pressure (blue connector) fitted with an extension line with Blue connector made in PVC

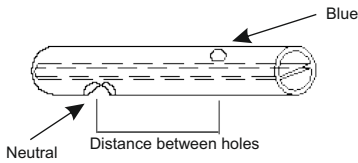

Code	No of ways	Cannula diameter	Cannula length	Distance between BLUE and NEUTRAL	Line length	Material	Q.tà/Box
2CYS-8PE	2	2.63 mm (8 Fr)	400 mm	10 mm	1800 mm	PVC	10

2CYS-9

Two-way catheter for bladder filling (white connector) and for the measurement of the Bladder Pressure (blue connector) 9 Fr

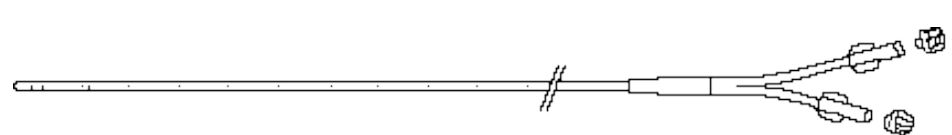
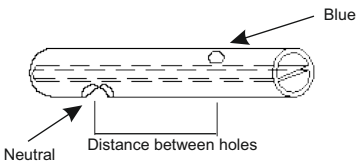

Code	No of ways	Cannula diameter	Cannula length	Distance between BLUE and NEUTRAL	Material	Q.tà/Box
2CYS-9	2	3 mm (9 Fr)	400 mm	10 mm	PEBAX	10

Catheters and lines for Urodynamics:

2OMNI-6N

Two-way catheter for bladder filling (white connector) and for the measurement of the Bladder Pressure (blue connector)
It can also be used for the Urethral pressure measurement

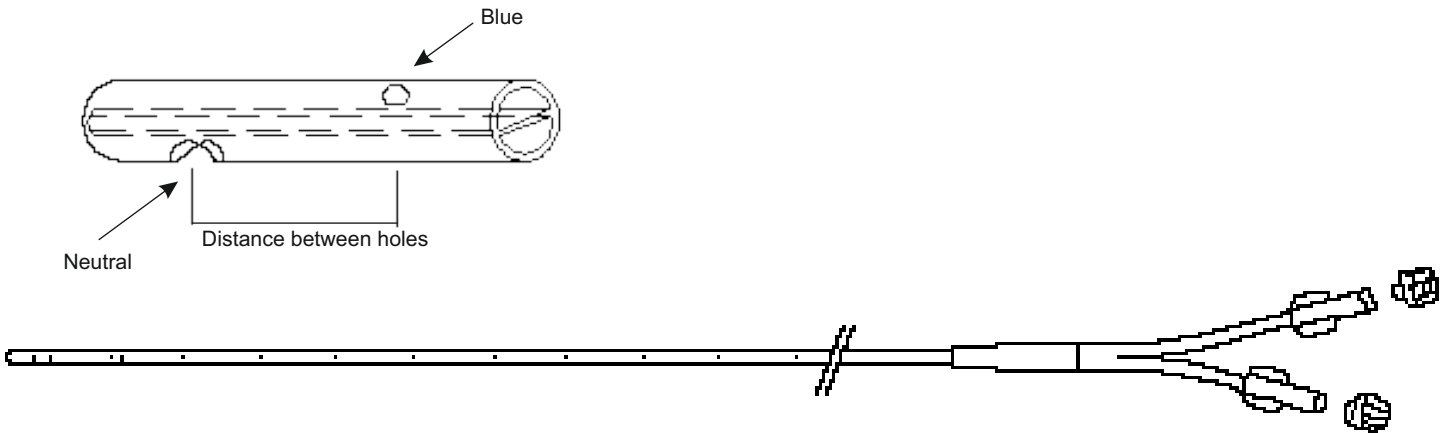

Code	No of ways	Cannula diameter	Cannula length	Distance between BLUE and NEUTRAL	Material	Q.ty/Box
2omni-6N	2	2 mm (6 Fr)	400 mm	60 mm	PEBAX	10

2OMNI-8P

Two-way catheter for bladder filling (white connector) and for the measurement of the Bladder Pressure (blue connector)
It can also be used for the Urethral pressure measurement

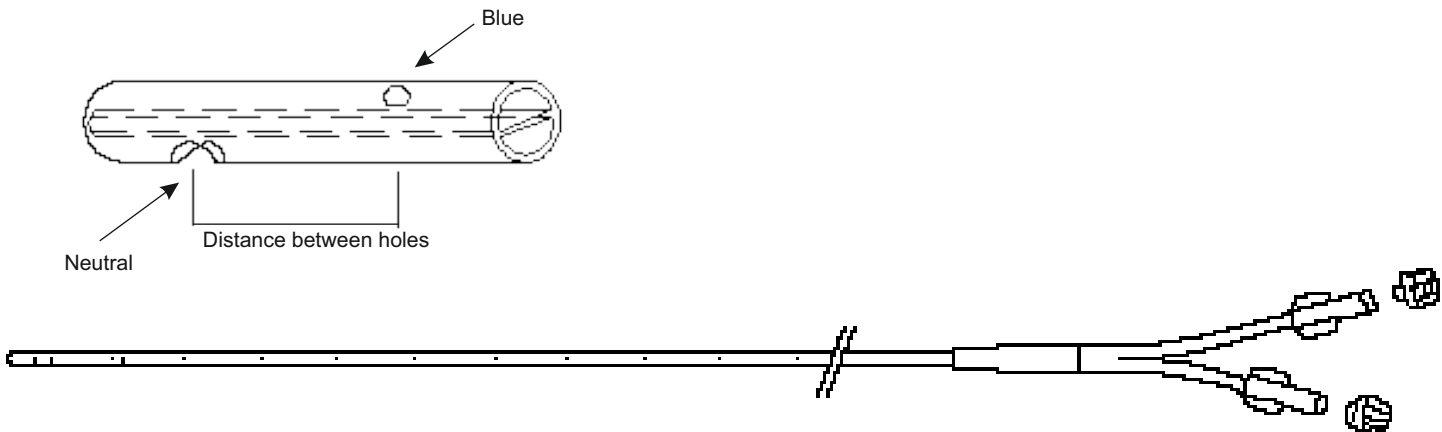

Code	No of ways	Cannula diameter	Cannula length	Distance between BLUE and NEUTRAL	Material	Q.ty/Box
2omni-8P	2	2.63 mm (8 Fr)	400 mm	60 mm	PVC	10

Catheters and lines for Urodynamics:

2OMNI-8PH

Two-way catheter for bladder filling (white connector) and for the measurement of the Bladder Pressure (blue connector)
It can also be used for the Urethral pressure measurement by simply exchanging the filling line with the Urethral Pressure line

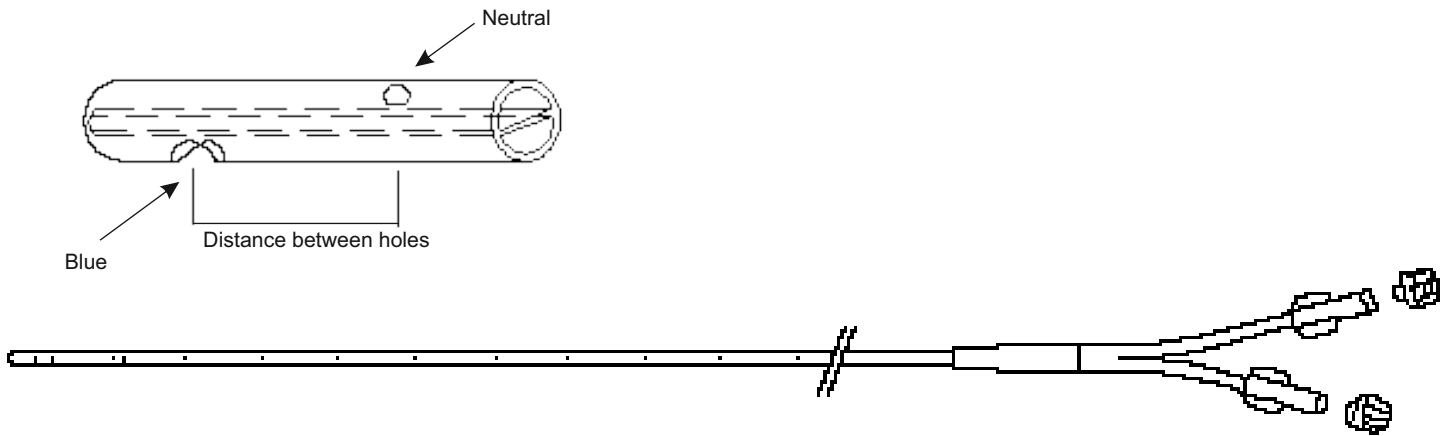

Code	No of ways	Cannula diameter	Cannula length	Distance between BLUE and NEUTRAL	Material	Q.ty/Box
2omni-8PH	2	2.63 mm (8 Fr)	400 mm	60 mm	PVC	10

2OMNI-9

Two-way catheter for bladder filling (white connector) and for the measurement of the Bladder Pressure (blue connector)
9 Fr

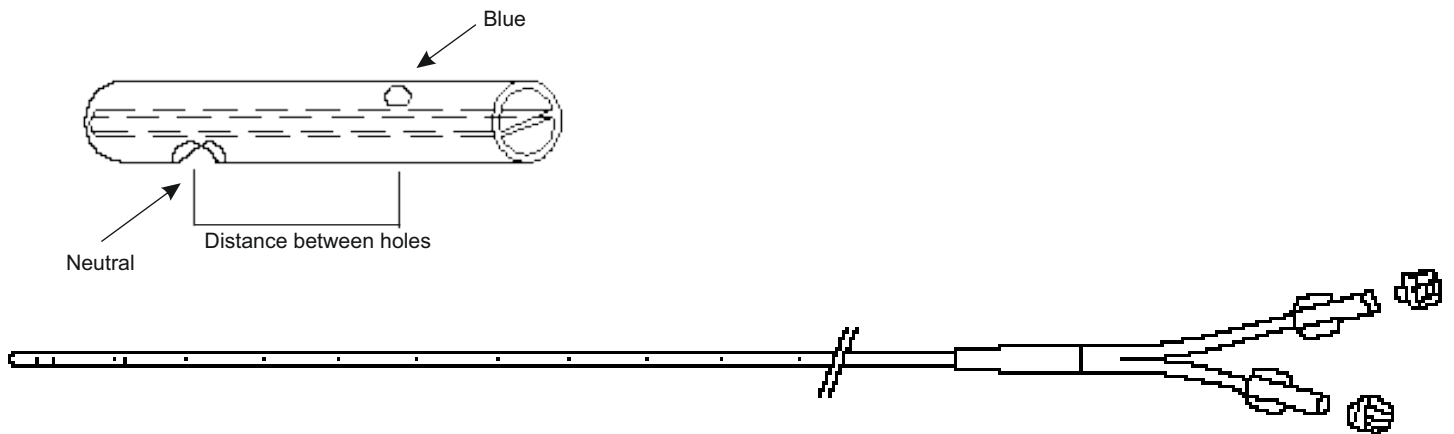

Code	No of ways	Cannula diameter	Cannula length	Distance between BLUE and NEUTRAL	Material	Q.ty/Box
2omni-9	2	3 mm (9 Fr)	400 mm	60 mm	PEBAX	10

Catheters and lines for Urodynamics:

3OMNI-8P and 3OMNI-9

Three way catheters for bladder filling (white connector), for the measurement of the Bladder pressure (Blue connector) and for the measurement of the Urethral Pressure (yellow connector). Made in PVC and in PEBAX

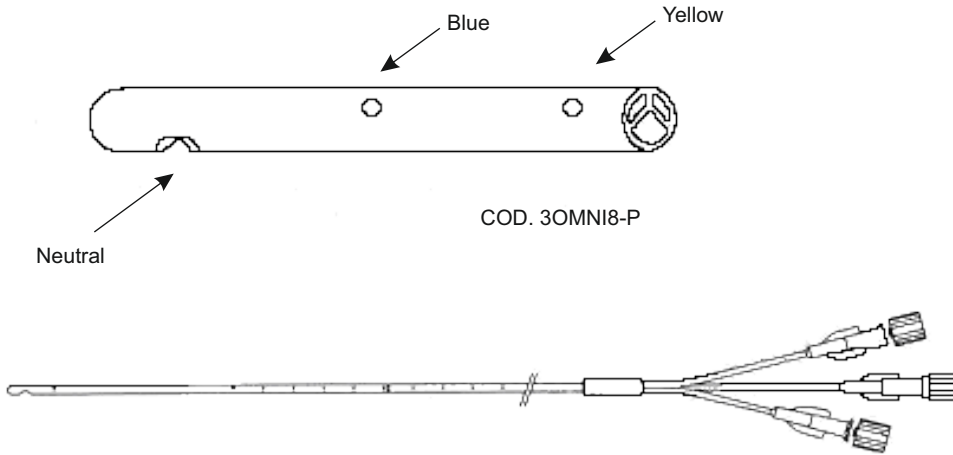

Code	No of ways	Cannula diameter	Cannula length	Distance between YELLOW and BLUE	Distance between BLUE and NEUTRAL	Material	Q.ty/Box
3omni-8P	3	2,63 mm (8 Fr)	400 mm	60 mm	10 mm	P.V.C.	10
3omni-9	3	3 mm (9 Fr)	400 mm	60 mm	10 mm	PEBAX	10

3OMNI-8UP

Three way catheters for bladder filling (white connector), for the measurement of the Bladder pressure (Blue connector) and for the measurement of the Urethral Pressure (yellow connector). The filling way and the Urethral pressure way open inside the same side-hole

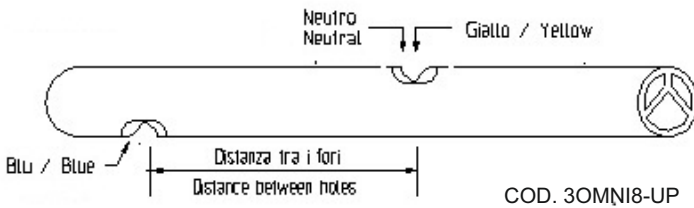

Code	No of ways	Cannula diameter	Cannula length	Distance between YELLOW and BLUE	Distance between BLUE and NEUTRAL	Material	Q.ty/Box
3omni-8UP	3	2,63 mm (8 Fr)	400 mm	60 mm	60 mm	P.V.C.	10

PVC yellow and Neutral open at the same hole

RECTAL BALLOON CATHETERS

1AR-5TI

One way catheter with a balloon mounted on the tip for the measurement of the abdominal pressure.
It is fitted with an introducer

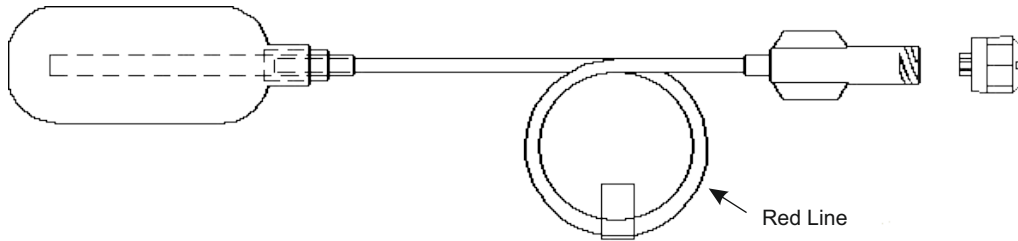

Code	No of ways	Cannula Diameter	Cannula Material	Balloon Diameter	Balloon length	Balloon Material	Q.ty/Box
1AR-5TI	1	1,5 mm (5 Fr)	PVC line 1800mm	15 mm	30 mm	PVC with introducer	10

1AR-5TC

One way catheter with a balloon mounted on the tip for the measurement of the abdominal pressure.
The balloon has a cutting to discharge the air when filling it with water

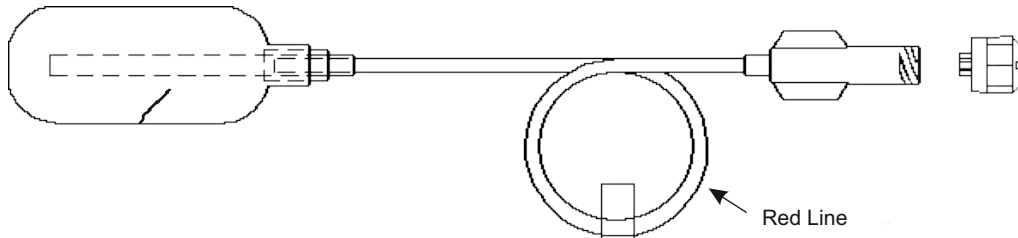

Code	No of ways	Cannula Diameter	Cannula Material	Balloon Diameter	Balloon length	Balloon Material	Q.ty/Box
1AR-5TC	1	1,5 mm (5 Fr)	PVC line 2000mm	15 mm	30 mm + cut	PVC with introducer	10

1AR-12SC

One way catheter with a balloon mounted on the tip for the measurement of the abdominal pressure.
Fitted with a Stop-cock

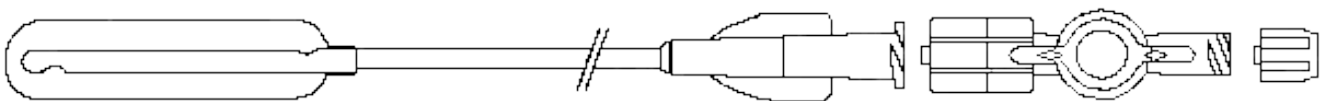

Code	No of ways	Cannula Diameter	Cannula Length	Cannula Material	Balloon Diameter	Balloon length	Balloon Material	Q.ty/Box
1AR-12SC	1	4 mm (12 Fr)	300mm + stopcock	PEBAX	15 mm	60 mm	Polyisoprene	10

Catheters and lines for Urodynamics:

2AR-9 and 2AR-XXXX

Two-way catheters with a balloon mounted on the tip. The white way is intended for discharging the air when filling the balloon with water through the red way. The item with the final E in the code are provided with an extension line

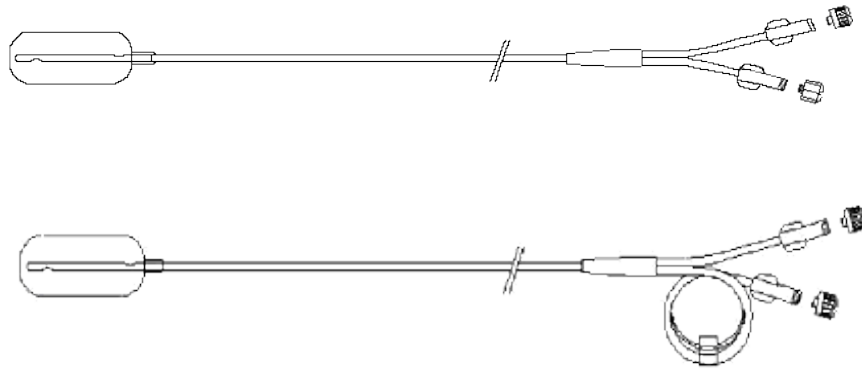
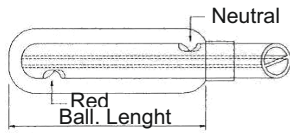

Code	Cannula Diameter	Cannula length	Cannula Material	Balloon Diameter	Balloon length	Balloon Material	Q.ty/Box
2AR-9	3 mm (9 Fr)	150 mm	PEBAX	7 mm	20 mm	POLYISOPRENE	10
2AR-9E	3 mm (9Fr)	150 mm	PEBAX + Line PVC 1800 mm	7 mm	20 mm	POLYISOPRENE	10
2AR-9T	3 mm (9 Fr)	400 mm	PEBAX	16 mm	30 mm	PVC	10
2AR-9TS	3 mm (9Fr)	200 mm	PEBAX	16 mm	30 mm	PVC	10
2AR-9TM	3 mm (9 Fr)	200 mm	PEBAX	10 mm	30 mm	PVC	10
2AR-12SM	4 mm (12 Fr)	180 mm	PEBAX	11 mm	43 mm	POLYISOPRENE	10
2AR-12MX	4 mm (12 Fr)	300 mm	PEBAX	15 mm	75 mm	POLYISOPRENE	10
2AR-12T	4 mm (12 Fr)	400 mm	PEBAX	16 mm	30 mm	PVC	10





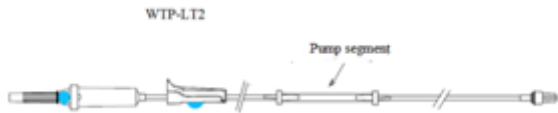
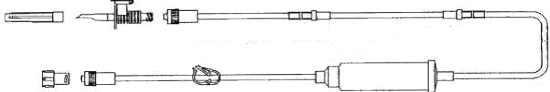
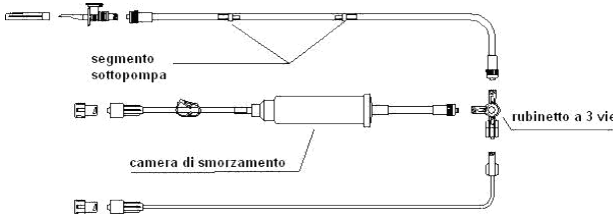

URODYNAMIC SETS

Code	Description
CPS-S-MX	1BF-8P + 1PF-5PE + 1AR-5TI
SET PF	1TIE-9 + 1PF-4L PIG
CPS-D-6MX	2CYS-6LE + 1AR-5TI
CPS-D-8MX	2CYS-8PE + 1AR-5TI
CPS-D-6M9	2CYS-6LE + 2AR-12-TE
CPS-D-8MX	2CYS-8PE + 1AR-5TI
CPS-D-6MX9	2CYS-6LE + 2AR-9TE
CPS-D-8MX12	2CYS-8PE + 2AR-12TE

LINES and ACCESSORIES

Code	Description	
WTP-LT2	Pump line for SAU and LIFE-Tech Pump	
WTP SET	Infusion Line with Pump Segment in PVC	
WTP/UP SET	Infusion Line with Pump Segment in PVC and lateral line with capillary	

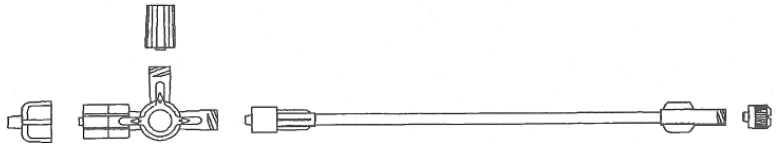
Code	Inner Diameter	External Diameter	Length	Material
WTP-LT2	Line: 2.9 mm Pump Segment: 3.1 mm	Line: 4.1 mm Pump Segment: 6.4 mm	Line: 1900 mm Pump Segment: 130 mm	PVC
WTP SET	Line: 3.5 mm Pump Segment: 3.1 mm	Line: 5.5 mm Pump Segment: 6.4 mm	Line: 1900 mm Pump Segment: 130 mm	PVC
WTP/UP SET	Line: 3.5 mm Pump Segment: 3.1 mm	Line: 5.5 mm Pump Segment: 6.4 mm	Line: 1900 mm Pump Segment: 130 mm	PVC

EXT-180	Extension Line 2.5 x 1800 mm, PVC, neutral	
EXT-180B	Extension Line 2.5 x 1800 mm, PVC, BLUE	
EXT-180Y	Extension Line 2.5 x 1800 mm, PVC, YELLOW	
EXT-180R	Extension Line 2.5 x 1800 mm, PVC, RED	
EXT-180/SC3	Extension Line 2.5 x 1800 mm, PVC with 3-way stopcock	
E34-180	Extension Line 3 x 4 x 1800 mm, PVC, neutral	

Catheters and lines for Urodynamics:

Sc2 2-way Stopcock

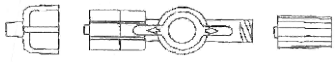

Sc3 3-way Stopcock

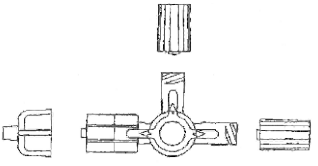

TCI Cuff-pump



QCI SET Quadruple Capillary set

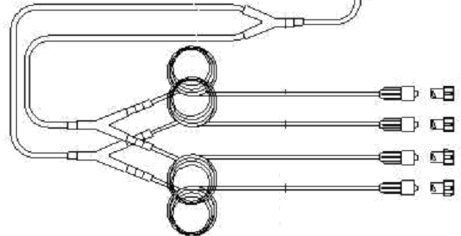

SCI Set Single Capillary set

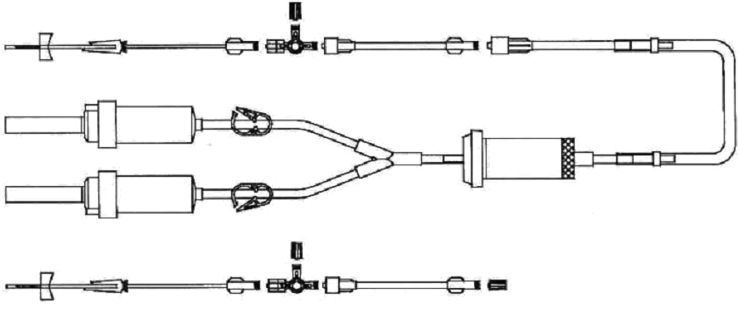

CAV Set Tubing Set for Cavernosometry

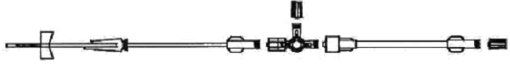

NRV Non return valve

Catheters and lines for Urodynamics:

TRANSDUCERS:

DPT-6100

Disposable pressure transducer by PVB



MX960

Reusable Pressure transducer



MX960X2SCP1

Disposable dome to be used with reusable transducer MX960.



TXPd

Disposable pressure transducer mod. TXPd



ELECTROMYOGRAPHY:

F9053N

Box of disposable surface electrodes 30 items per box)



MA-A004/25

Disposable needle electrode, monopolar, 25 x 0.36 mm.

MA-A004/38

Disposable needle electrode, monopolar, 38 x 0.46 mm.

MA-A004/50

Disposable needle electrode, monopolar, 50 x 0.46 mm.



UROFLOWMETRY:

PICO FLOW2

PICO FLOW2 is a double-channel uroflowmeter for uroflowmetry and Electromyography examinations of the Pelvic Floor. Thanks to its advanced technical features PICO FLOW 2 is especially designed for urodynamic examinations in paediatric and gynaecology departments and whenever one chooses to perform a non-invasive urodynamic examination.



FLOW ZIG

FLOW ZIG, is the MEDICA Wireless Uroflowmeter,



MCH1

Commode Chair



Catheters and lines for Urodynamics:

BLADDER SCANNER:

PALM BLADDER SCANNER PBSv 4.1



The scanner is small in size, easy to use, has a long battery life and a smart calibration function. This last feature is new and means that with every setting up of the device, a previous calibration will show so that the measured results will be validated.

The machine will be delivered complete with battery and charger.

To printer is built-in. The Palm Bladder Scanner is a hand held device and the perfect answer for easy transportation between different hospital locations or for use in primary care environment such as a continence service delivering homecare.

ELECTROTHERAPY AND BIOFEEDBACK:

Totem UG

Wireless unit for ELECTROTHERAPY ELECTRODIAGNOSIS & BIOFEEDBACK .



Catheters and lines for Urodynamics:

PERIPROBE®

Cod. RU-Minima

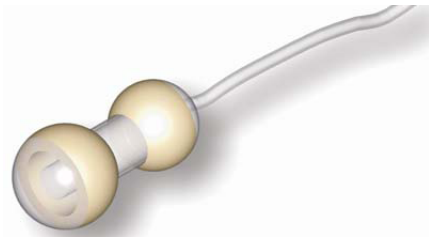

Cod. RU-Analis



RU-V2STW



RU-A2STW



Distributor

**Menfis
Division**

Divisional Office:
Via della Beverara, 46/D - 40131 Bologna Italy.
Tel +39 051 635 10 74 - Fax +39 051 635 10 81
E-mail: info@menfis.it - Web site: www.menfis.it

Rev. 1.16 Feb 2017



MEDICA S.p.A.
via degli artigiani, 7
41036 MEDOLLA MODENA - ITALY